

PRIOR ART

Fig. 1

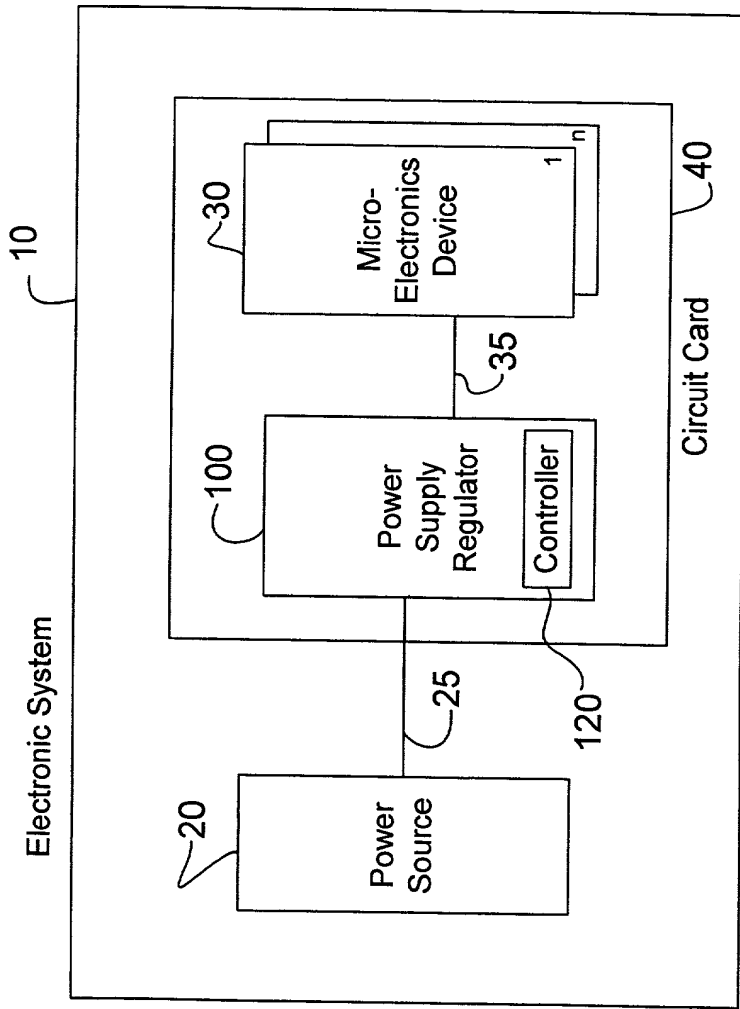

Fig. 2

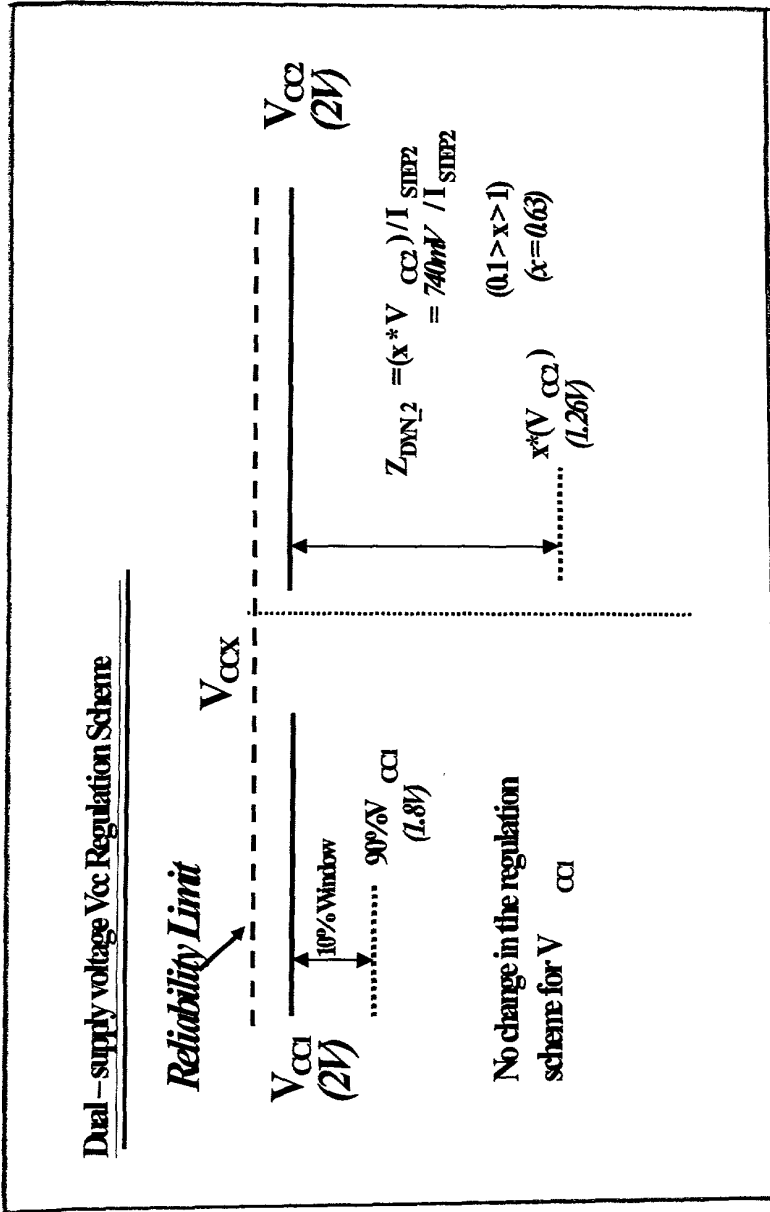

Fig. 3

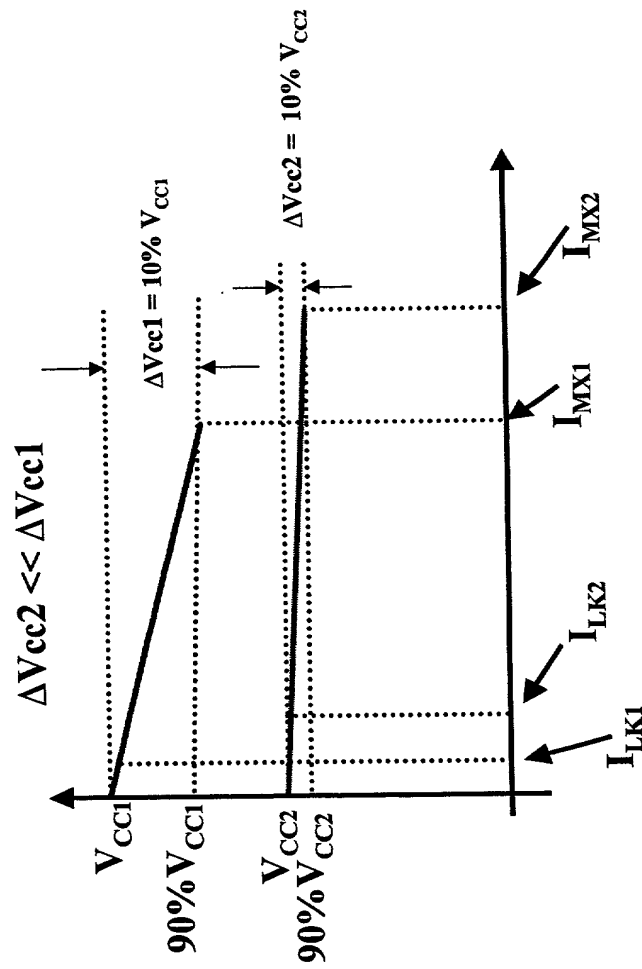

Fig. 4

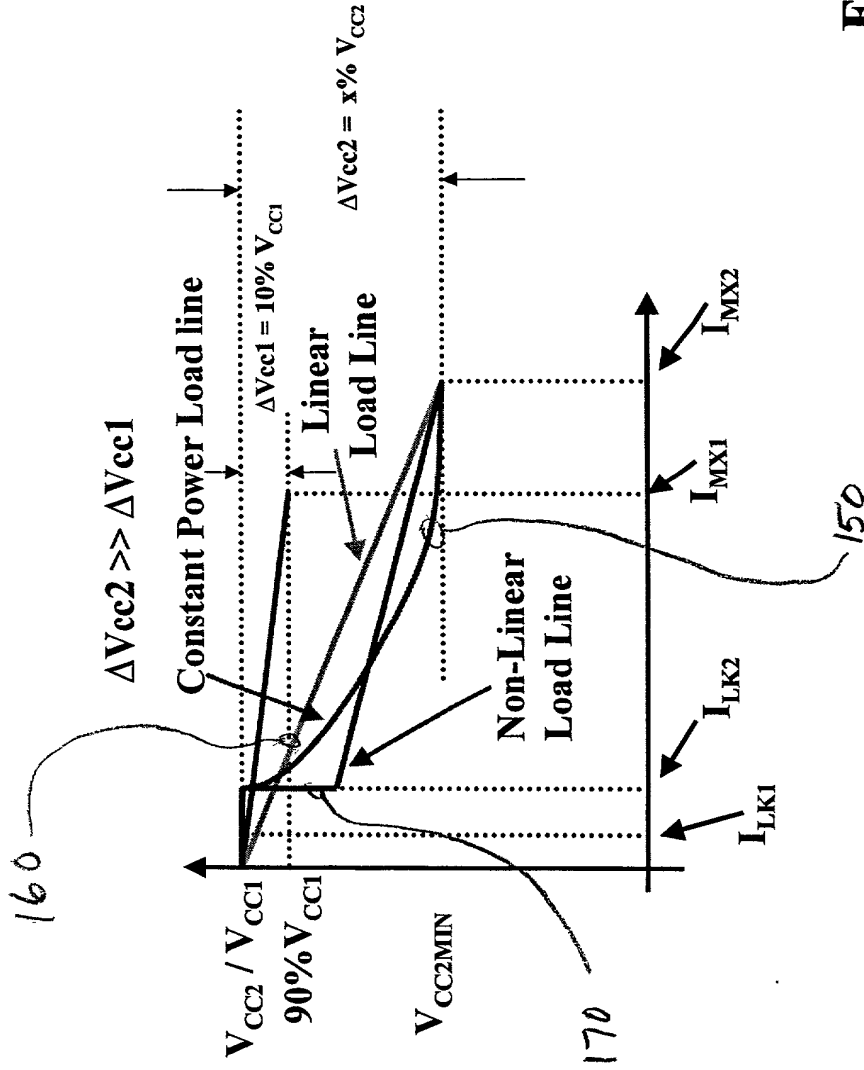
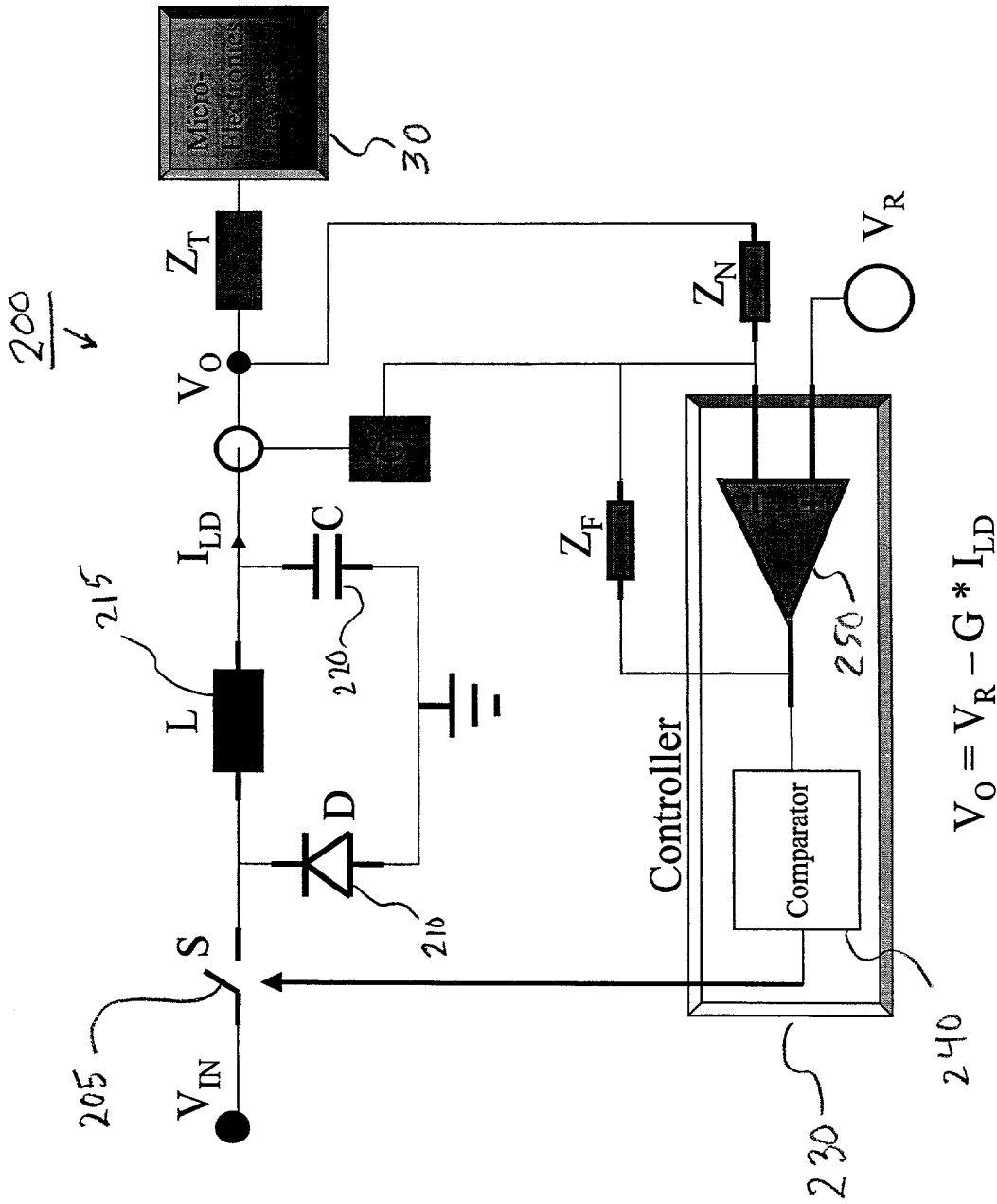

Fig. 5



Z_F & Z_N form the compensation network

Fig. 6

Patent for Section 300

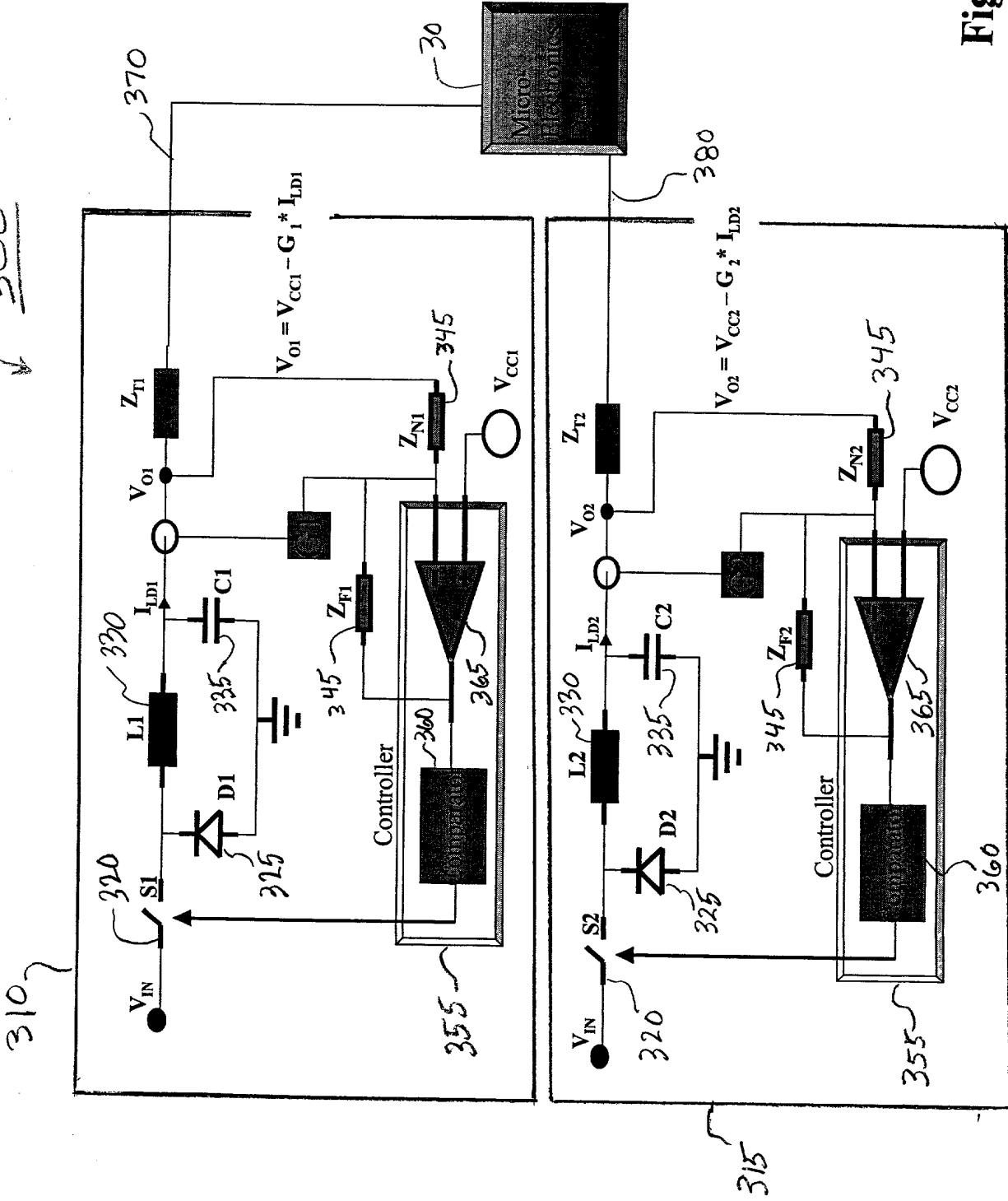

Fig. 7

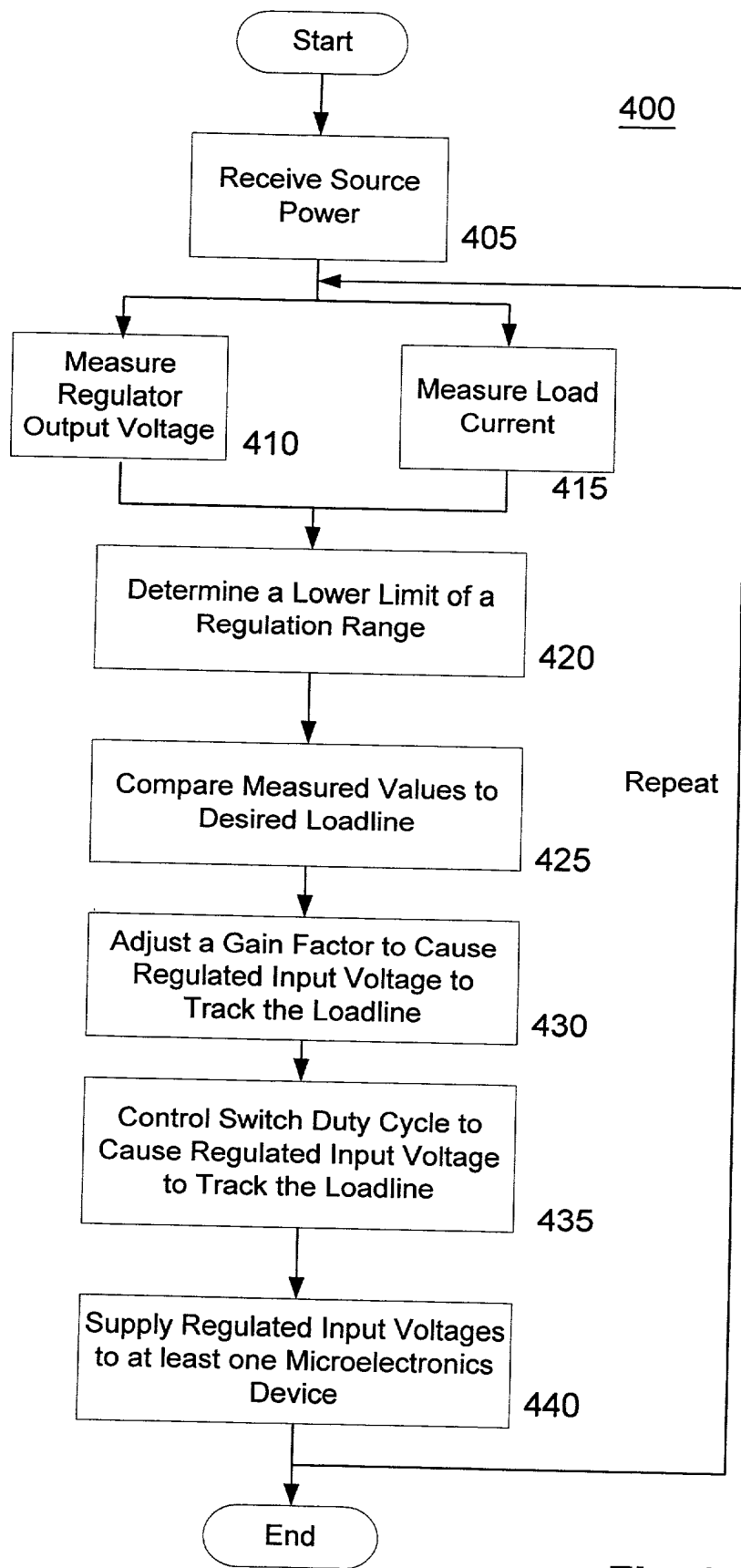

Fig. 8